

MOT-VE100D

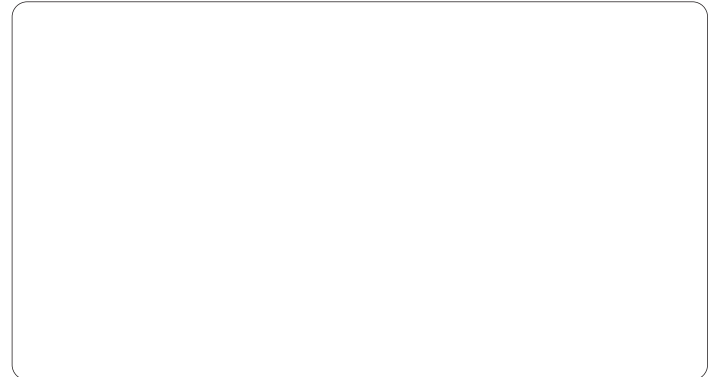

EC	REP	EMERGO EUROPE Westervoortsedijk 60, 6827 AT Arnhem The Netherlands	CE
----	-----	---	----

 Caution	•Prior to product use, carefully read and comprehend the contents of the user manual and product packaging information.
	•Inspect the product routinely and thoroughly, in addition to pre- and postoperative examinations.
	•For after-sale support, contact your local dealer / distributor.



Mizuho Medical Co.,Ltd.

MIZUHO Building 3, 3-29-3 Hongo,
Bunkyo-ku, Tokyo 113-0033, JAPAN

Phone +81-3-3815-7101
F a x +81-3-3818-1705
U R L www.mizuhomedical.co.jp
E-mail mm.marketing@mizuho.co.jp



MIZUHO Corporation

3-30-13 Hongo, Bunkyo-ku, Tokyo 113-0033, JAPAN
<https://www.mizuho.co.jp>

* Under our policy, ongoing improvements and published specifications may be subject to change without prior notice.
* All published CG photos and illustrations have been from images.
©MIZUHO 2023



MOT-VE100D

Versatile entry model with exceptional quality and performance



MOT-VE100D

The MOT-VE100D offers all the safety and functionality features you need in an operating table together with user-friendly operation for efficient surgery.

It is a general-purpose model designed for a wide range of settings from general operating rooms through to day surgery facilities and emergency rooms.



HAND CONTROLLER

- ▶ High-quality operating table with Made-in-Japan reliability.
- ▶ Made by Mizuho, which has nearly a century of experience in the manufacture of operating tables and thorough knowledge of surgical procedures.
- ▶ Excellent durability with rigid structure equivalent to other high-spec Mizuho models.
- ▶ Intuitive and user-friendly hand control with easy-to-see buttons.

Features

Attachment System Chart

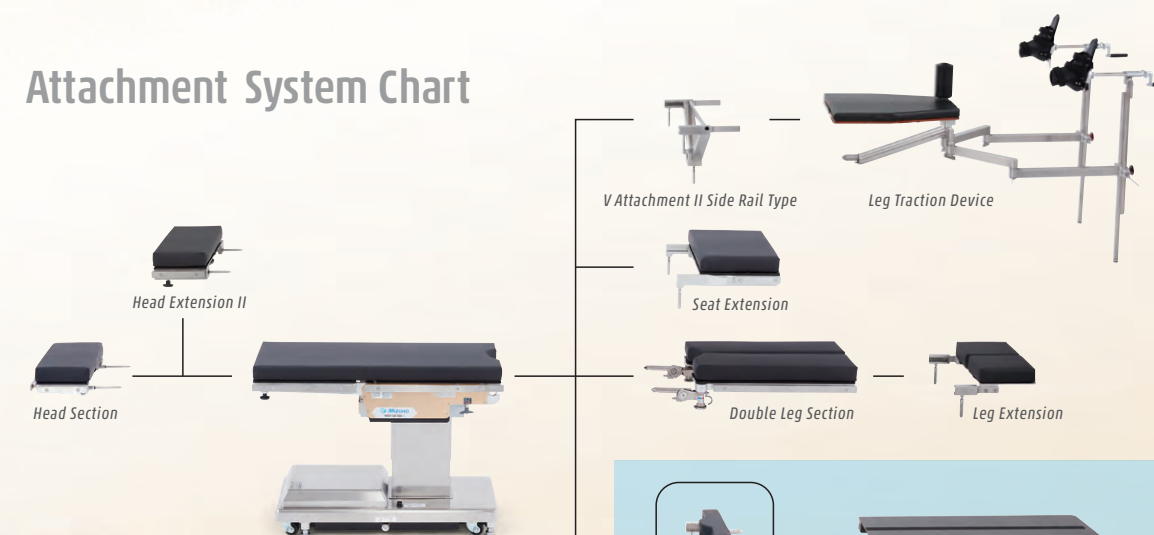

▶ The MOT-VE100D has the same interface as other Mizuho models to accommodate a wide range of attachments and add functionality for many different surgical procedures.

for Reverse Position

By connecting the Leg-side Reversal Adapter C, various accessories can be mounted onto the leg side for use in reverse position.

The reversal adapter is used for patients in reverse position. It provides improved imaging access to the upper and lower body and a generous working area for the surgeon. The optional Carbon Fiber Extension Board* extends the imaging area further. * Available separately

photo : with Reversal Adapter and Carbon Fiber Extension II 100 cm ▶



Other Features

Weight Capacity

The patient weight capacity for elevation and articulation is 250 kg / 555 lbs.



Easy Removable Leg Section

The leg section is easy to attach and remove via pin joints. Slide into position and tighten screw knobs to lock in place. This simple structure reduces the OR set-up time.

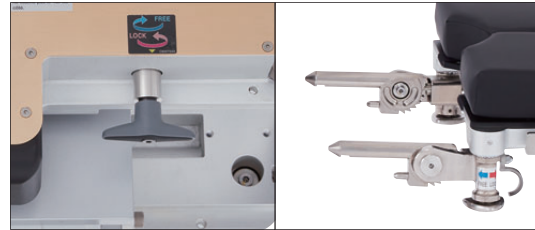

a : Screw Knob

b : Pin Joint

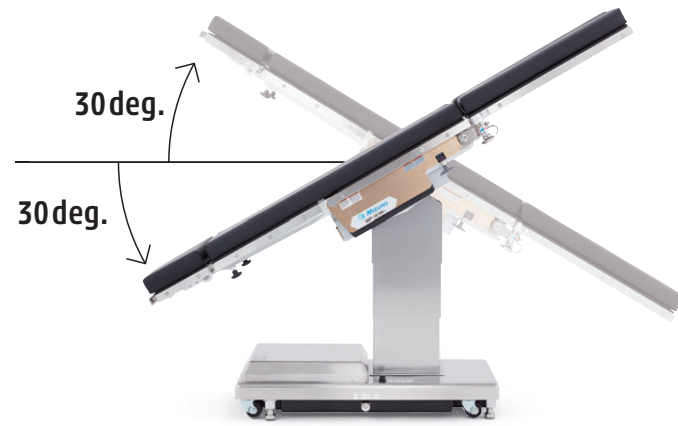
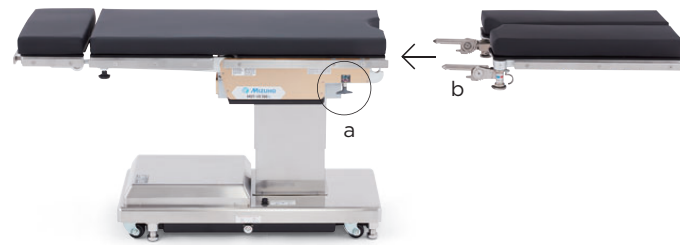

Trendelenburg

Trendelenburg angle of up to 30 deg. for endoscopy procedures.

Positions

Suitable for a wide range of procedures, from general surgery to orthopedics and neuro surgery.

Normal Position



Orthopedic Surgery
Femur Fracture / Supine Position



Laparoscopic Surgery



Urology / OB-GYN with Seat Extension

Reverse Position



Spine Surgery



Orthopedic Surgery Shoulder / Beach Chair Position

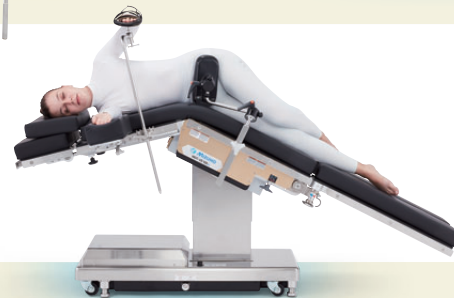

Nephrectomy / Lateral Position



Half Sitting Position with Head Extension



Spine Surgery

* Wilson Plus™ Radiolucent Frame and ProneView® are sold by Mizuho OSI

Safety Features

AUX Switch

Flush mounted Aux Switch is located directly underneath the tabletop to permit swift responses if the hand controller malfunctions.

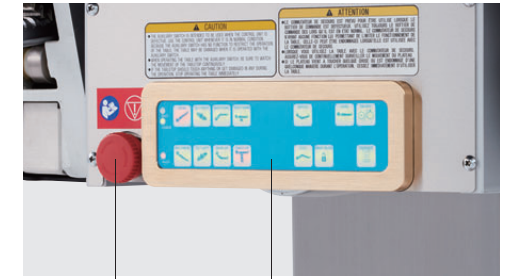

AUX Switch

Emergency Stop Switch

Emergency Stop Switch

If the emergency stop switch is pressed, the table's power supply is immediately shut off so that various electrical problems can be dealt with.

Emergency Brake Release Knob

For releasing the brake manually in case of power outage.



Battery Indicator

Easily check the battery level at a glance via the battery indicator.



Optional Accessories

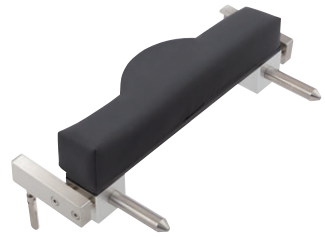

Leg-side Reversal Adapter C

08-077-50	Leg-side Reversal Adapter C	JP Side Rail
08-077-50-R1	Leg-side Reversal Adapter C (R1)	US Side Rail
08-077-50-R2	Leg-side Reversal Adapter C (R2)	EU Side Rail

*Pad not included

Pad / Radiographic Table Top for Leg-side Reversal Adapter

18-042-90	Mizuho Original Pad for Leg-side Reversal Adapter
18-097-00	Digital Radiographic Table Top for Leg-side Reversal Adapter

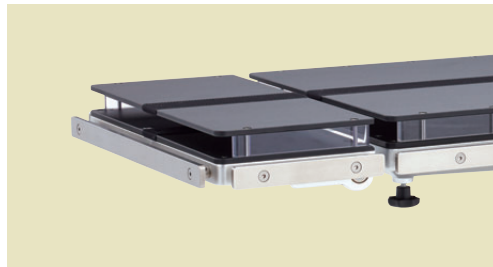

Digital Radiographic Table Tops Fixed Type

*Digital Film compatible



Radiographic Table Tops Fixed Type

*Variety of other accessories available. Refer to the accessories catalog or inquire at your nearest Mizuho distributor or sales office.

Table Functions

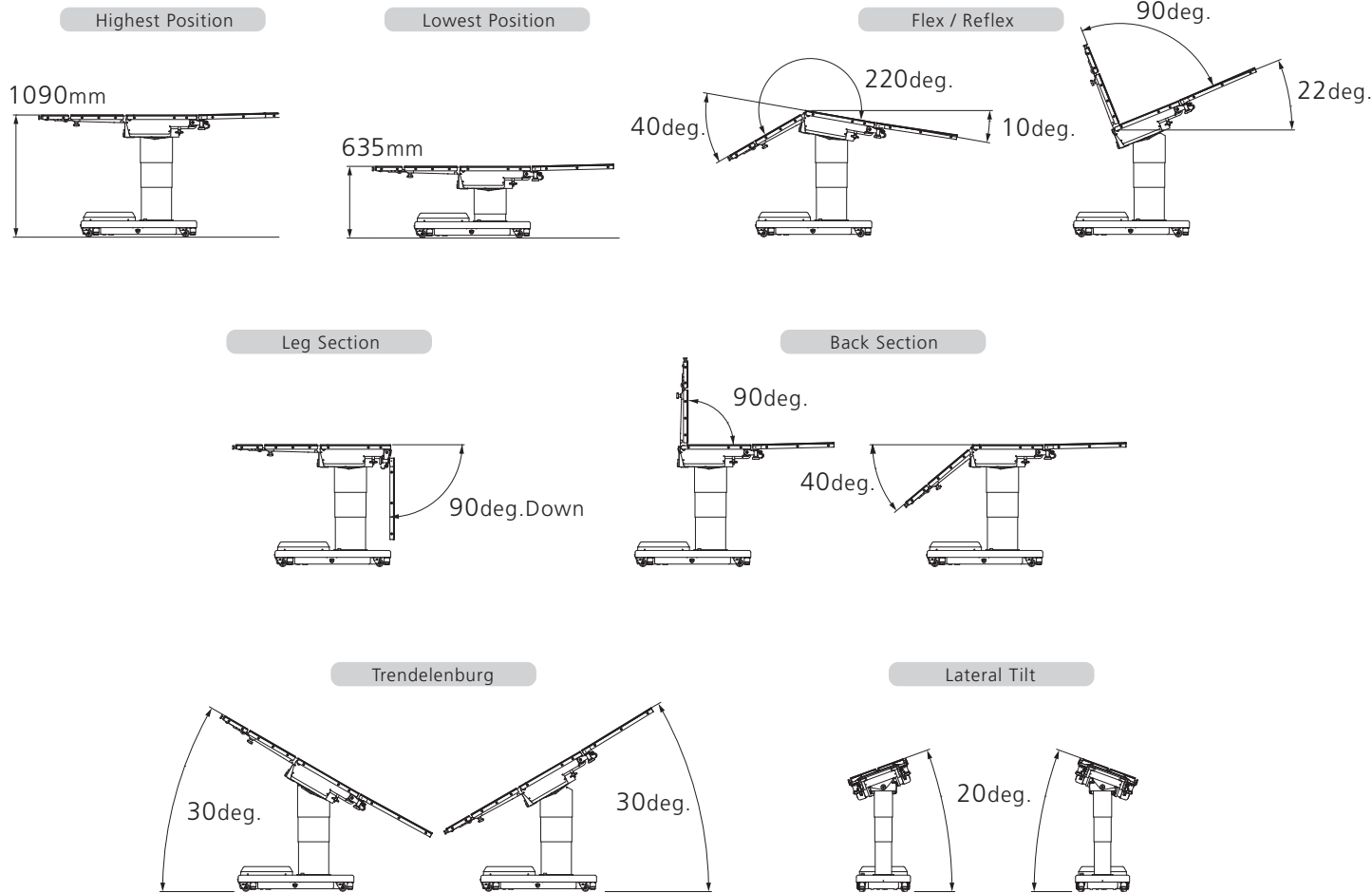

Specifications

MOT-VE100D

Product Description	MOT-VE100D		
Product Code	18-263-20	MOT-VE100J	JP Side Rail
	18-263-30	MOT-VE100De	EU Side Rail
	18-263-70	MOT-VE100Da	US Side Rail
Trade Name	Operating Table MOT-VE100D		
Drive System	Electro Hydraulic System		
Country of Origin	Japan		
Elevation Range	635 mm - 1090 mm		
Trendelenburg	Head Up 30 deg. / Head Down 30 deg.		
Lateral Tilt	20 deg. Left / Right		
Back Section	90 deg. Up / 40 deg. Down		
Flex Angle (Auto Position)	220 deg.		
Reflex Angle (Auto Position)	90 deg.		
Head Section	60 deg. Up / 90 deg. Down		
Leg Section	90 deg. Down		
Leg Section Opening Angle	90 deg.		
Return to Level	Trendelenburg / Lateral Tilt / Back Section / Flex / Reflex		
Maximum Permissible Load Elevation	250 kg (555 lbs.) in Normal / 135 kg (300 lbs.) in Reverse		
Maximum Permissible Load Articulation	250 kg (555 lbs.) in Normal / 135 kg (300 lbs.) in Reverse		
Table Top Dimensions	500 mm x 2133 mm		
Base Dimensions	483 mm x 1033 mm		
Table Weights	360 kg		
Supply Voltage	AC 100 - 240 V		
Power Consumption	400 VA		
Battery Power	DC 24 V		
Operating Voltage	DC 5 V, 24 V		
Standard Accessories	Table Pads / Wired Hand Controller		
Power Cord Options	To be selected according to country type		

Main Material

Table Plate	Phenolic Resin
Side Rail	Stainless Steel
Side Frame	Aluminum Alloy
Elevation Column (Cover)	Stainless Steel
Base (Cover)	Stainless Steel

Operating Environment

Ambient Temperature	10 to 40 °C
Relative Humidity	30 to 75 %
Atmospheric Pressure	700 to 1060 hPa

Outer Dimension Drawing

MOT-VE100D

